

A close-up photograph of a blue metal shelving unit. The image shows the vertical blue frame on the left and two horizontal grey shelves. The top shelf is slightly above the frame, and the bottom shelf is below it. The background is white.

ST30  
ST60

 **METALCOOP**

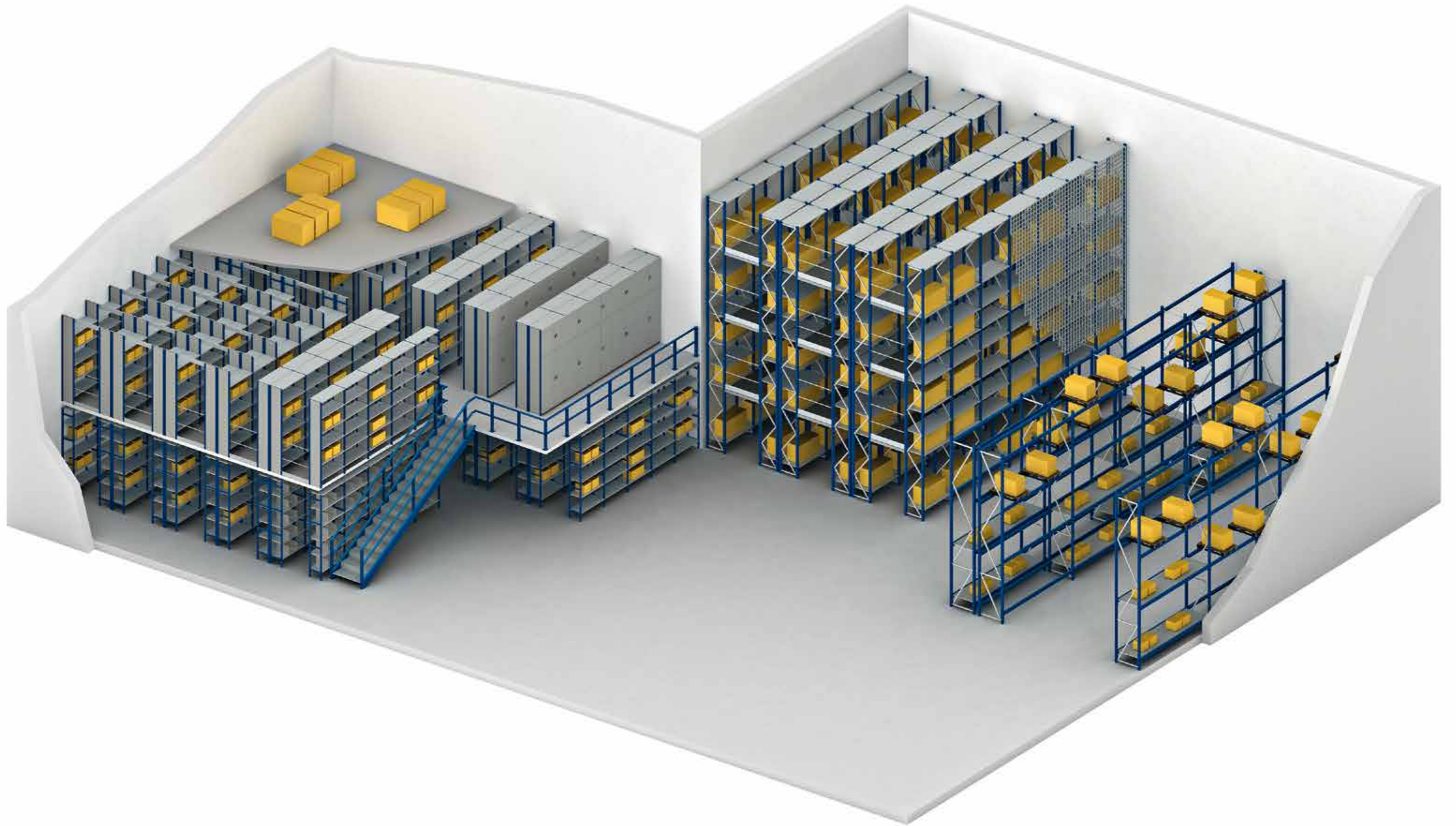





ST30

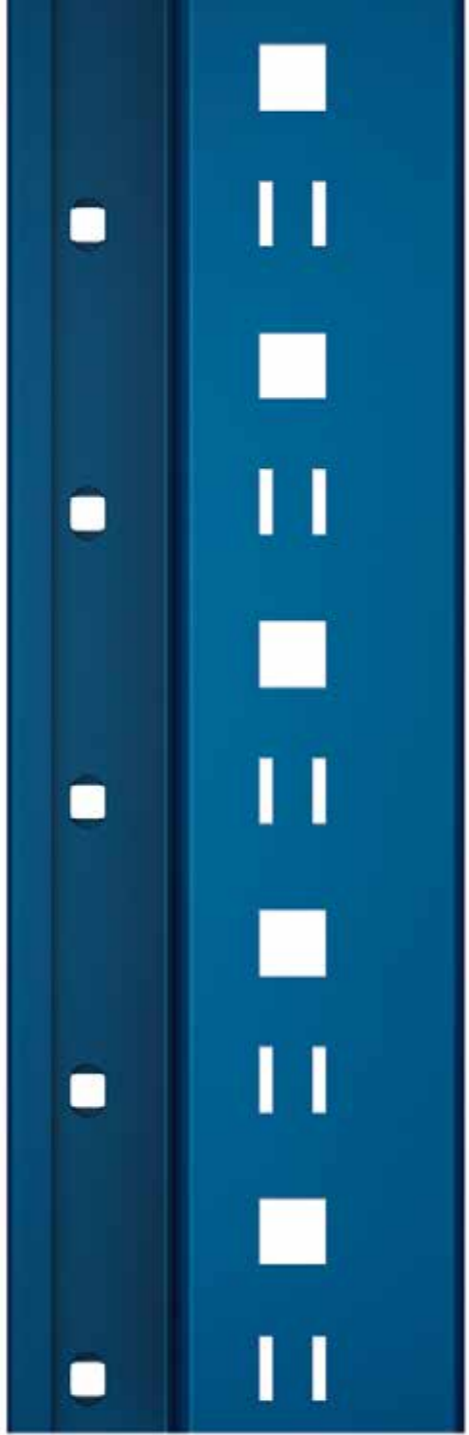
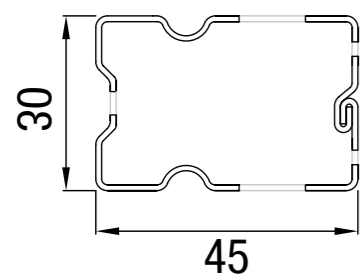

ST60

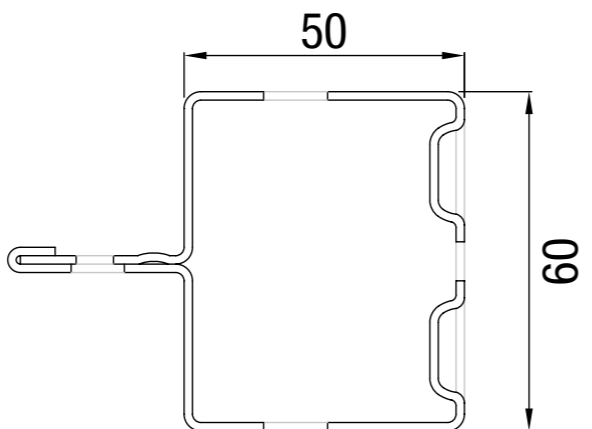

Scaffale tipo:

Anno di Installazione:

Ordine n°

Portata max piano:

A = kg

Portata max spalla:

B = kg

Distanza tra piani

C = mm

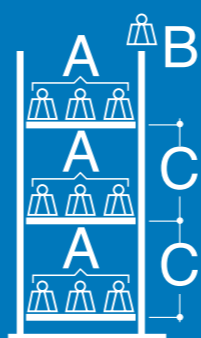

**METALCOOP**  
50052 CERTALDO  
tel. 0571 666433  
Made in ITALY

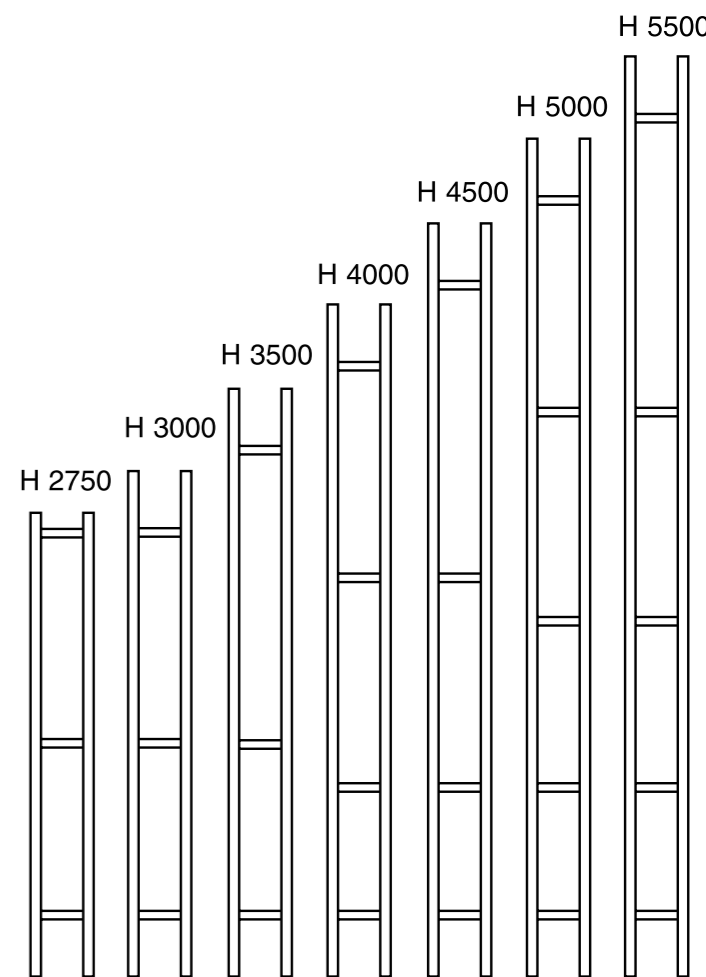
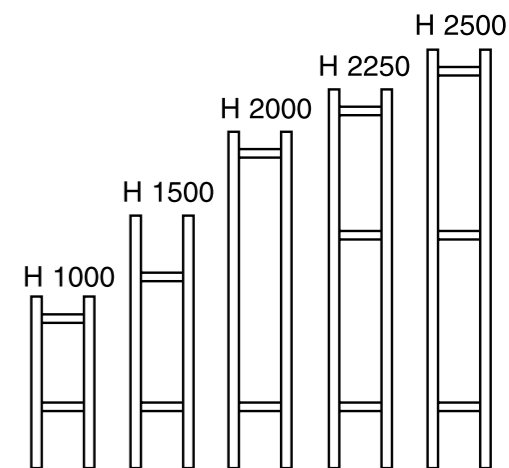
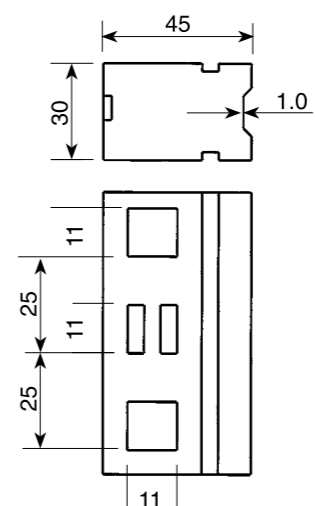
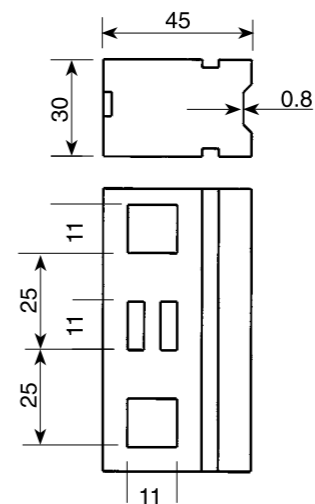



R0



R0



R1



R1

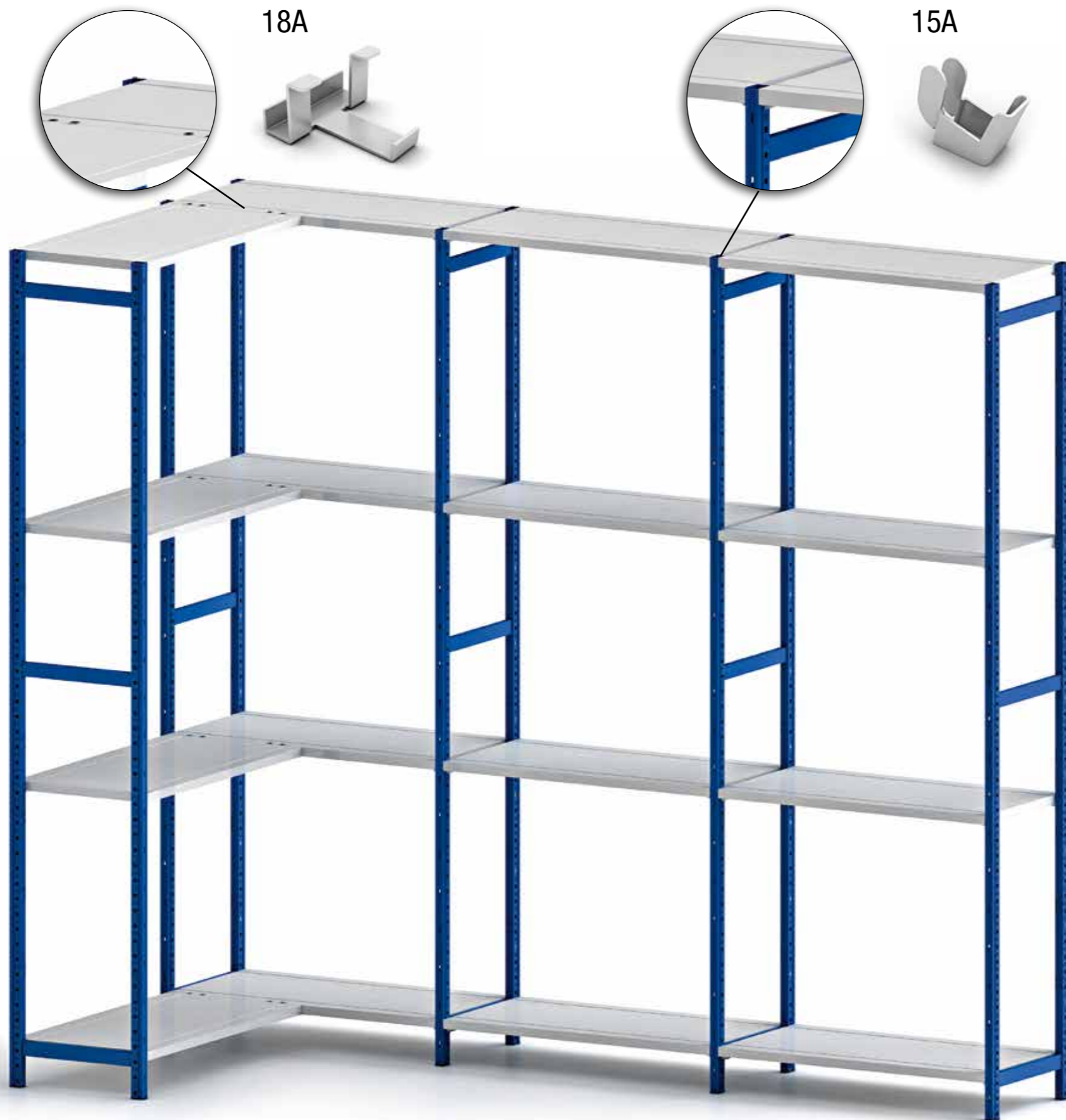

18A

15A

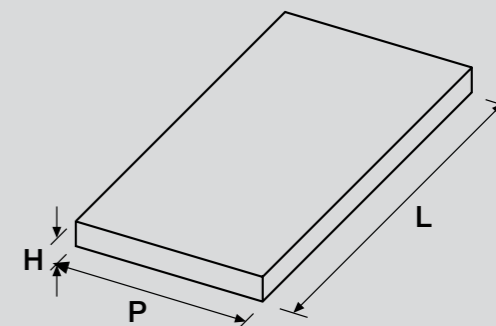

PIANO VEGA STANDARD

H (mm)	P (mm)	L (mm)	KG	KG	
R0	300	800	1,92	200	
		1.000	2,35	180	
		1.200	2,77	160	
	30	350	800	2,1	200
			1.000	2,56	180
			1.200	3,02	160
		400	800	2,28	200
			1.000	2,78	180
			1.200	3,28	160
500	800	3,16	220		
	1.000	3,86	200		
	1.200	4,55	180		
R1	30	500	1.000	4,32	250
			1.200	5,09	180
		600	800	3,97	240
	1.000		4,84	240	
	1.200		5,71	180	

PIANO VEGA OPTIONAL

H (mm)	P (mm)	L (mm)	KG	
R0	300	600	1,2	
		1.500	3,4	
	30	350	600	1,64
			1.500	3,72
		400	600	1,78
	1.500		4,03	
R1	500	600	2,47	
		1.500	5,6	
	30	600	1.500	6,26
			600	3,1
		700	1.500	7,02
			600	3,43
800			4,39	
1.000			5,36	
800		1.200	6,32	
		1.500	7,77	
	600	3,76		
	800	4,32		
1.000	5,88			
1.200	6,94			
1.500	8,53			

4x10 kg.



17x10 kg.



34x10 kg.







42A



44A

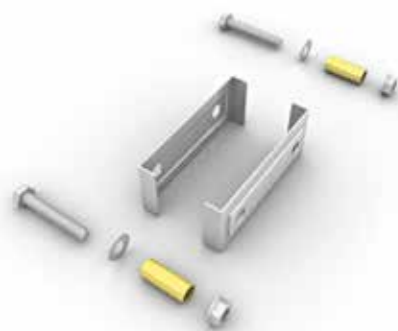

45A



48A

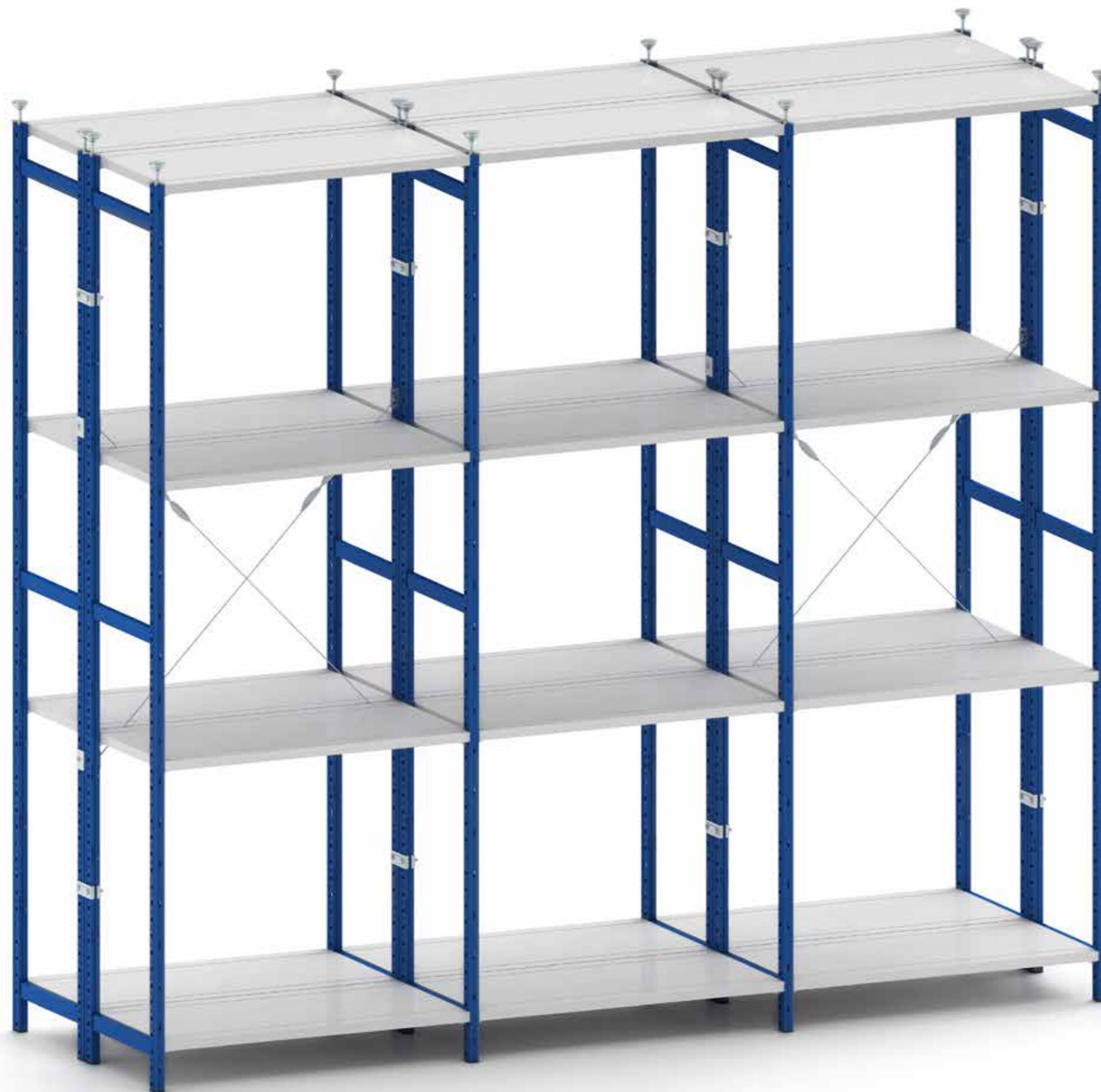

35A



38A



37A



5A



4A

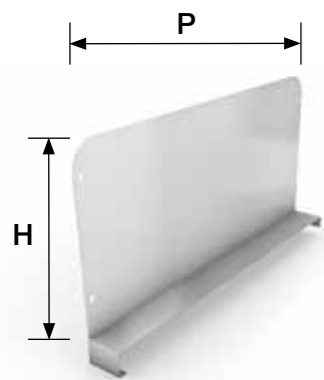

P (mm)	H (mm)
300	140
	240
400	140
	240
500	140
	240
600	140
	240

21A

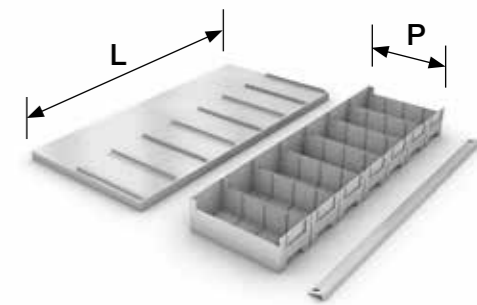
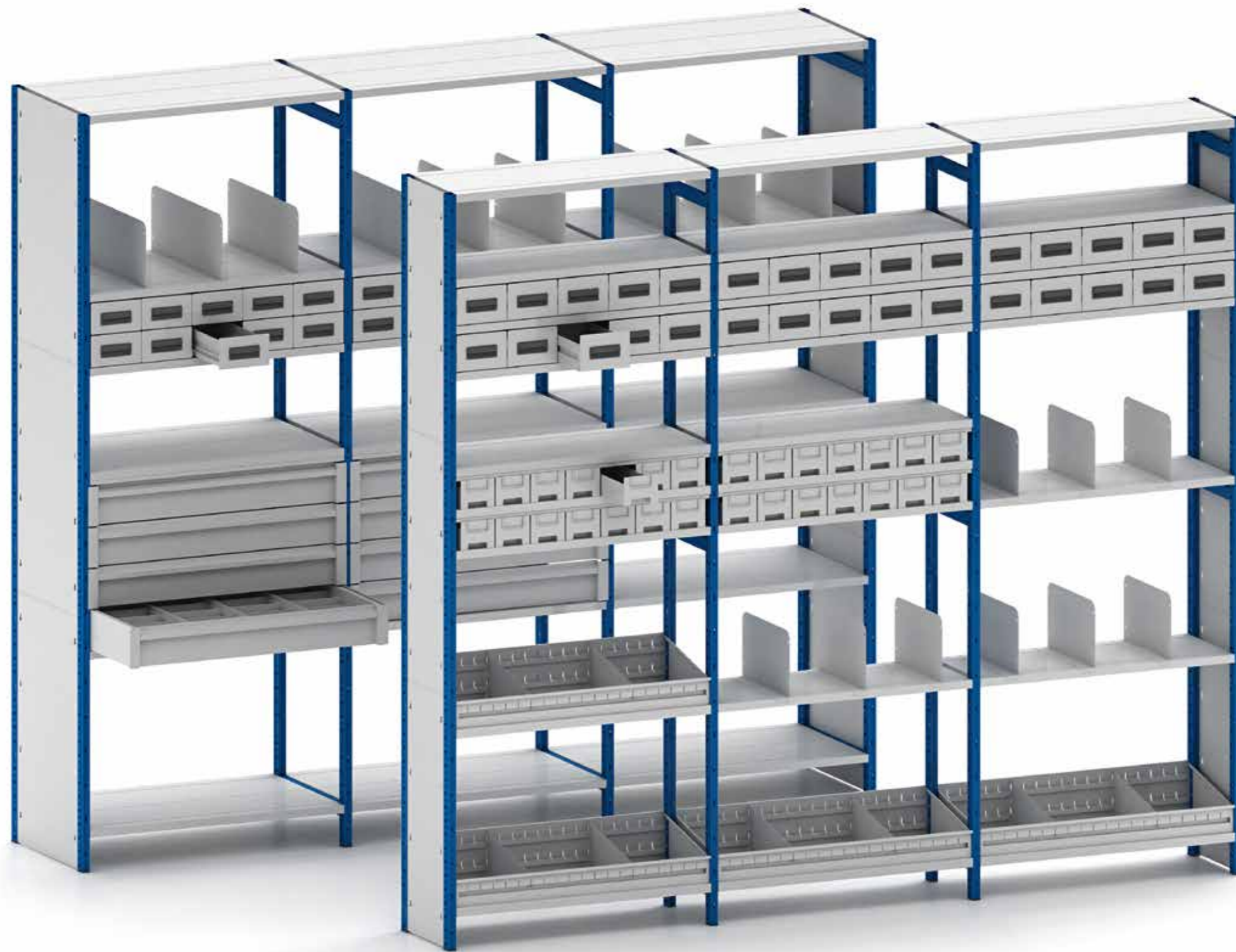

P (mm)	L (mm)
300	1.000
400	

29A

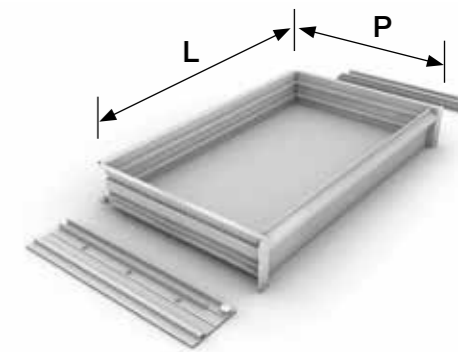

H=100 H1=70  
H=150 H1=120  
H=200 H1=170

P (mm)	L (mm)
500	1.000
600	

33A

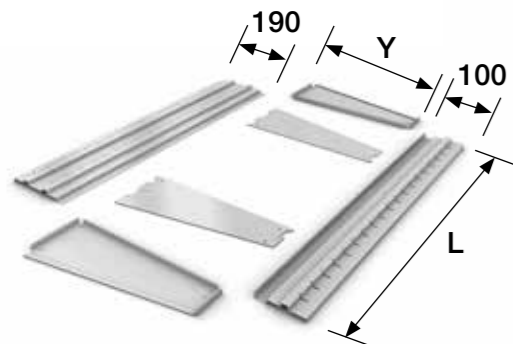

L (mm)	Y (mm)
800	300
1.000	400
	500
1.200	600

23A

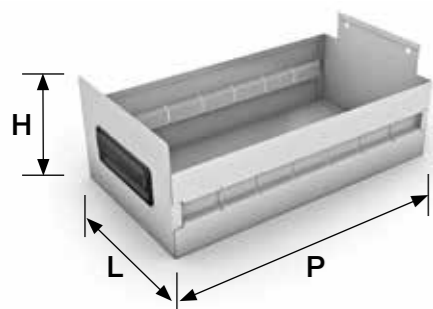

OUT (mm)	IN (mm)
P 400	365
L 400	180
H 135	100

26A

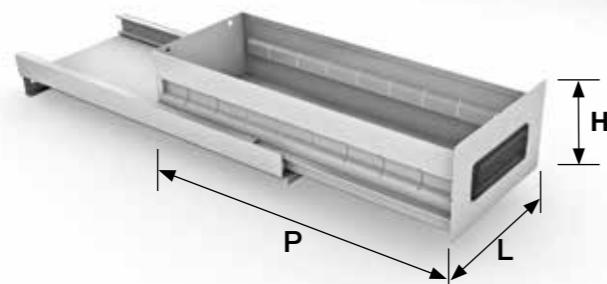

OUT (mm)	IN (mm)
P 500/600	455/555
L 200	150
H 135	95

27A

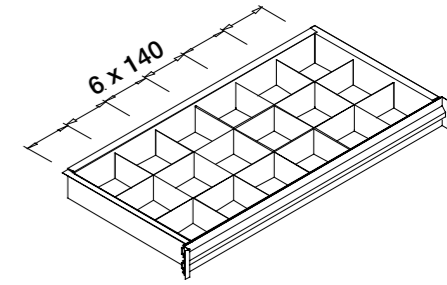
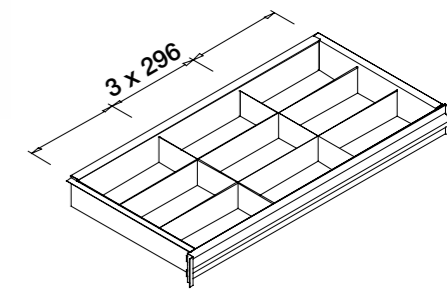
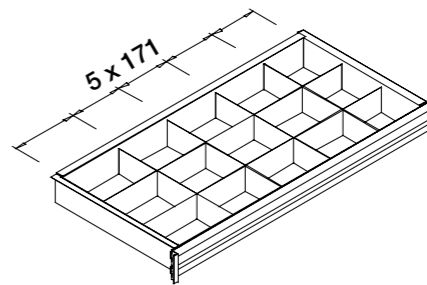
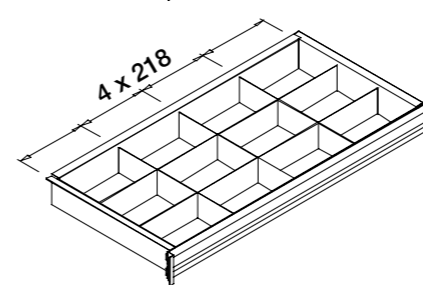
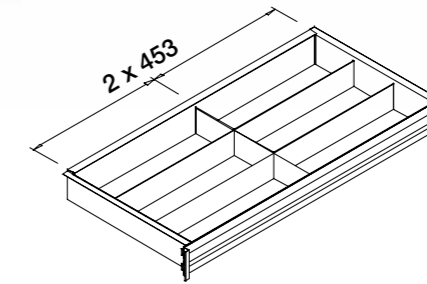
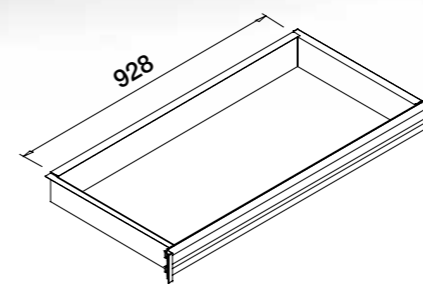



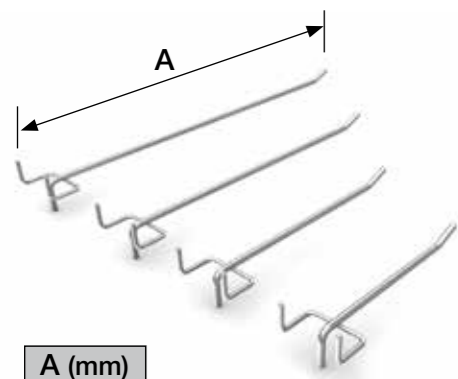

A (mm)
150
200
300
400

52A

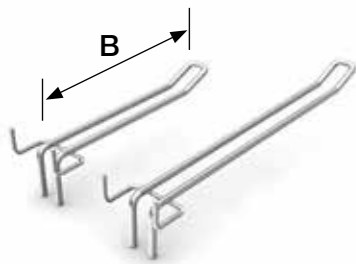

B (mm)
200
300

53A

C (mm)	D (mm)
500	750
500	1.750
600	750
600	1.750

54A

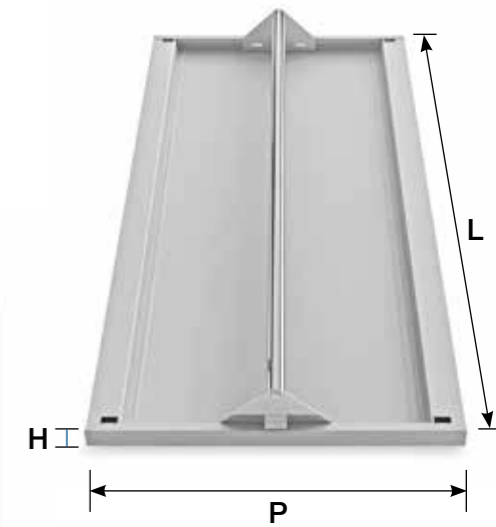
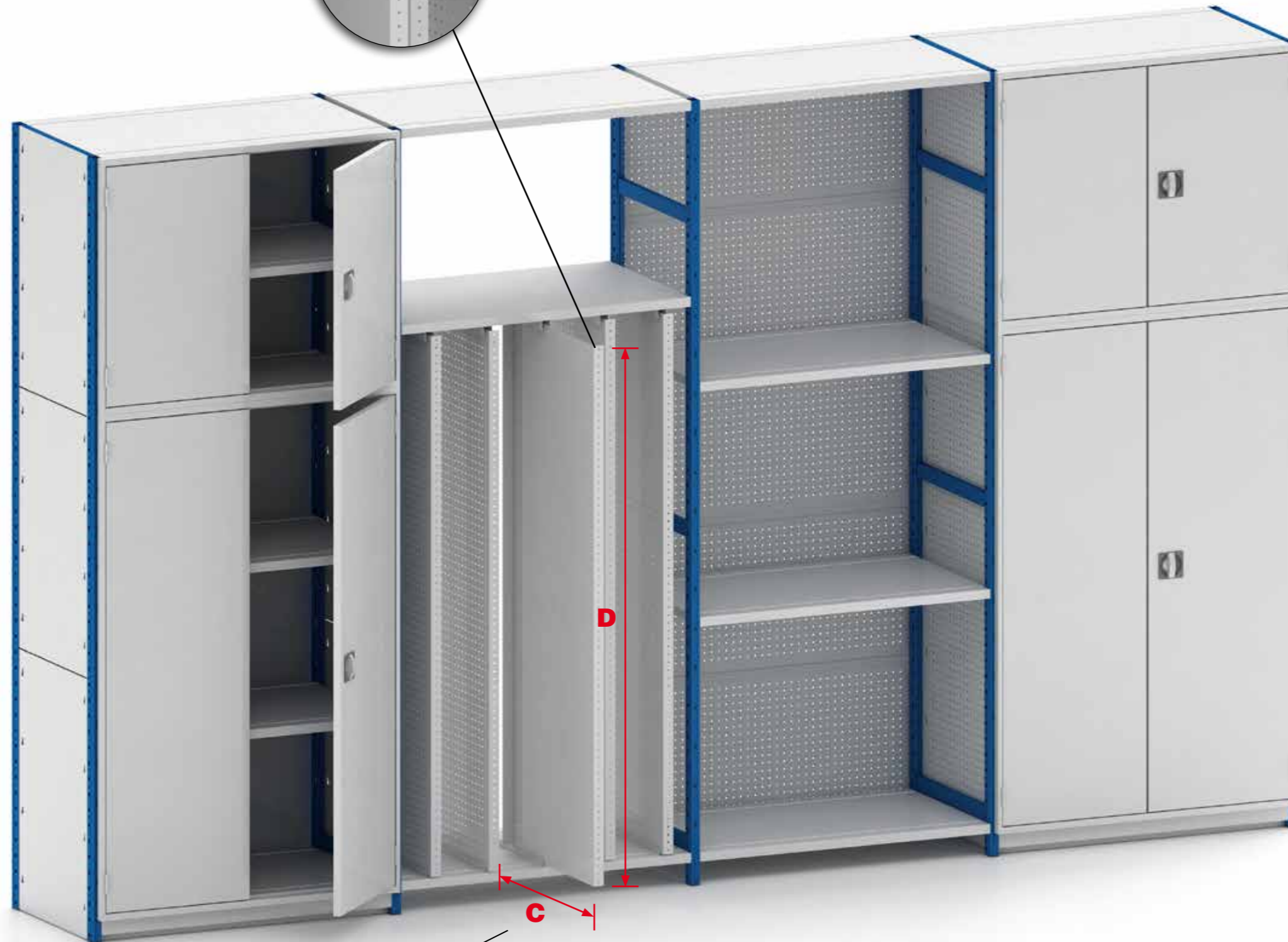
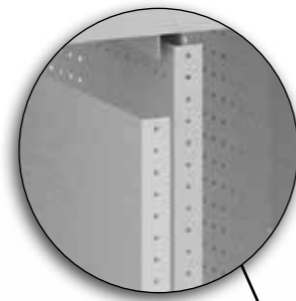

H (mm)	P (mm)	L (mm)	
30	300	800	
		1000	
		1200	
	350	400	800
			1000
			1200
	500	600	800
			1000
			1200

25A

A (mm)
100

55A

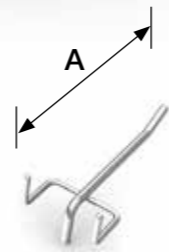

A (mm)	B (mm)
800	800
	1600
	1800
1000	800
	1600
	1800
1200	800
	1600
	1800



58A



59A



63A

H1 (mm)	H2 (mm)
2000	2030
2500	2530
3000	3030

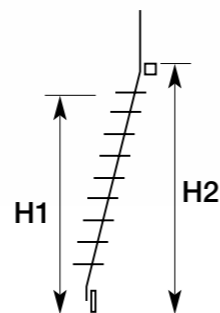

62A

H1 (mm)	H2 (mm)
2000	2030
2500	2530
3000	3030

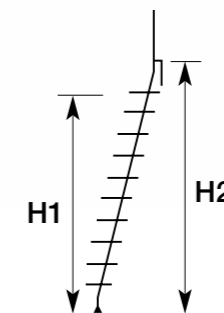

64A

H (mm)
1500
2000
2500

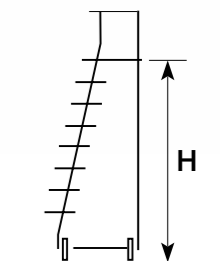



Aderente a:



ASSOCIAZIONE  
FRA I COSTRUTTORI  
IN ACCIAIO ITALIANI

Cert. n° IT - 5480 - IGQ 2A33

 **METALCOOP**

Via delle Regioni, 265  
50052 Certaldo (Fi) Italia  
Tel. +39 0571 666 433  
Fax +39 0571 667 836  
P.IVA 04516830488  
metalcoop@metalcoop.it  
www.metalcoop.it

